



Long Life Reliability
does not cost the earth



Contents

Industrial Connectors	2
LPA Niphan Range	3-4
Guard Ring Plug	5-6
Trailing Socket	7-8
Flange Socket 'A' type	9-10
Flange Socket 'B' type	11-12
Accessories	13-14
Appliance Inlet	15-16
Panel Mount	17-18
Bespoke Assemblies & Cable Harnesses	19-20
Nato (NSN) Cross Reference	21
Technical Information	22



Industrial Connectors



Plugs, Sockets, Trailing Sockets,
Appliance Inlets & Bespoke Cable Assemblies

- Compact and robust
- Simple installation
- NATO approved
- Corrosion resistant
- Operating temperature range of -20 to +85°C
- IP66 rated
- Fire resistance to PH120 within the range
- Low smoke and toxicity
- High shock resistant
- Up to 500V, 500A
- Screw terminals - no special tool is required
- Long life sprung contacts
- Halogen and Cadmium free
- Part number traceability

LPA Niphan Range

The LPA Niphan range of industrial connectors are designed for use in hostile and rugged environments including industrial, rail, marine, defence, infrastructure and aerospace . The Niphan range continues to be the first choice for specifiers and users.



Product Range Overview



2 pin

voltage	amps	guard ring plug	trailing socket	appliance inlet	flange socket 'A' (3 hole fixing)	flange socket 'B' (2 hole fixing)	mount box 'A' flange SKT only
<50V	5	X2P/ODD	X2J/ODD	X2Q/ODD	X2A/ODD	X2B/ODD	-
<250V	10	12S	12J	12R	12A	12B	1274
<250V	10	12S/ODD	12J/ODD	12R/ODD	12A/ODD	12B/ODD	1274
<250V	15	22S	22J	22R	22A	22B	16302
<250V	15	22S/ODD	22J/ODD	22R/ODD	22A/ODD	22B/ODD	16302



2 pin + earth

voltage	amps	guard ring plug	trailing socket	appliance inlet	flange socket 'A' (3 hole fixing)	flange socket 'B' (2 hole fixing)	mount box 'A' flange SKT only
<50V	5	X3P	X3J	X3R	X3A	X3B	-
<250V	10	13S	13J	13R	13A	13B	1274
<250V	15	23S	23J	23R	23A	23B	16302
<250V	30	33S	33J	33R	33A	33B	2766
<500V	50	43S	43J	43R	43A	-	1169
<500V	60	93S	93J	93R	93A	-	2333
<500V	100	53S	53J	53R	53A	-	2333



3 pin + earth

voltage	amps	guard ring plug	trailing socket	appliance inlet	flange socket 'A' (3 hole fixing)	flange socket 'B' (2 hole fixing)	mount box 'A' flange SKT only
<50V	10	X4S	X4J	X4R	X4A	X4B	1274
<250V	15	64S	64J	64R	64A	64B	2766
<500V	15	74S	74J	74R	74A	74B	2766
<500V	60	94S	94J	94R	94A	-	2333
<500V	100	C4S	C4J	C4R	C4A	-	-

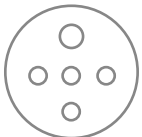

4 pin + earth

voltage	amps	guard ring plug	trailing socket	appliance inlet	flange socket 'A' (3 hole fixing)	flange socket 'B' (2 hole fixing)	mount box 'A' flange SKT only
<250V	10	X5S	X5J	X5R	X5A	X5B	16302
<250V	15	65S	65J	65R	65A	65B	2766
<250V	30	75S	75J	75R	75A	-	1169
<500V	50	85S	85J	85Q	85A	-	2333
<500V	60	95S	95J	95Q	95A	-	-
<500V	250	N52/05	-	-	N55/05	-	-



5 pin + earth

voltage	amps	guard ring plug	trailing socket	appliance inlet	flange socket 'A' (3 hole fixing)	flange socket 'B' (2 hole fixing)	mount box 'A' flange SKT only
<250V	10	X6S	X6J	X6R	X6A	X6B	16302
<500V	30	76P	76J	76Q	76A	-	2333

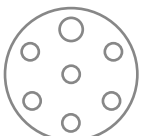

6 pin + earth

voltage	amps	guard ring plug	trailing socket	appliance inlet	flange socket 'A' (3 hole fixing)	flange socket 'B' (2 hole fixing)	mount box 'A' flange SKT only
<50V	10	X7S	X7J	X7R	X7A	-	16302
<250V	10	17P	17J	17Q	17A	-	1169
<500V	30	77P	77J	77Q	77A	-	2333
<500V	60	97P	97J	97Q	97A	-	-



7 pin + earth

voltage	amps	guard ring plug	trailing socket	appliance inlet	flange socket 'A' (3 hole fixing)	flange socket 'B' (2 hole fixing)	mount box 'A' flange SKT only
<250V	10	18P	18J	18Q	18A	-	1169

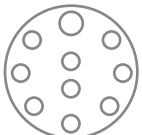

9 pin + earth

voltage	amps	guard ring plug	trailing socket	appliance inlet	flange socket 'A' (3 hole fixing)	flange socket 'B' (2 hole fixing)	mount box 'A' flange SKT only
<250V	10	X10P	X10J	X10Q	X10/A	-	1169

Guard Ring Plug



- IP66 rated
- Noryl insulator
- Good creep resistance
- High dielectric strength
- Halogen and Cadmium free
- Excellent insulation properties
- Saddle clamps manufactured from Zytel nylon resin

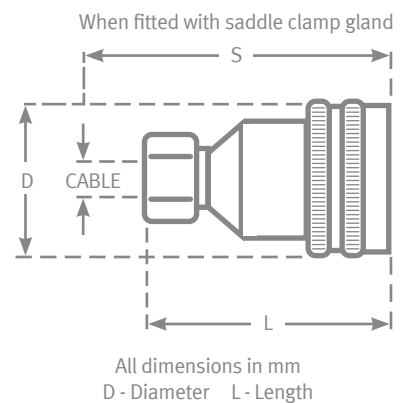

Product Range Overview



2 pin

voltage	amps	part number	dimensions			saddle clamp*
			D	L	S	
<50V	5	X2P/ODD	26	40	52	26725/GFN
<250V	10	12S	35	57	69	26724/GFN
<250V	10	12S/ODD	35	57	69	26724/GFN
<250V	15	22S	43	80	92	26723/GFN
<250V	15	22S/ODD	43	80	92	26723/GFN

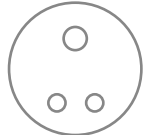

2 pin + earth

voltage	amps	part number	dimensions			saddle clamp*
			D	L	S	
<50V	5	X3P	26	40	52	26725/GFN
<250V	10	13S	35	57	69	26724/GFN
<250V	15	23S	43	80	94	26723/GFN
<250V	30	33S	56	92	102	26722/GFN
<500V	50	43S	65	108	120	26721/GFN
<500V	60	93S	89	-	145	-
<500V	100	53S	89	-	180	-



3 pin + earth

voltage	amps	part number	dimensions			saddle clamp*
			D	L	S	
<50V	10	X4S	35	57	69	26725/GFN
<250V	15	64S	54	77	89	26723/GFN
<500V	15	74S	56	92	102	26722/GFN
<500V	60	94S	89	-	145	-
<500V	100	C4S	133	-	215	-

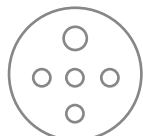

4 pin + earth

voltage	amps	part number	dimensions			saddle clamp*
			D	L	S	
<250V	10	X5S	43	80	94	26723/GFN
<250V	15	65S	54	77	89	26723/GFN
<250V	30	75S	65	108	120	26721/GFN
<500V	50	85P	83	-	126	-
<500V	60	95P	121	-	162	-
<500V	100	N52/05	235	-	315	-

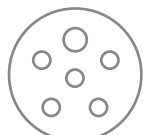

5 pin + earth

voltage	amps	part number	dimensions			saddle clamp*
			D	L	S	
<250V	10	X6S	43	80	94	26723/GFN
<500V	30	76P	83	N/A	126	N/A

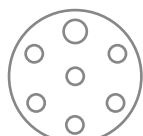

6 pin + earth

voltage	amps	part number	dimensions			saddle clamp
			D	L	S	
<50V	10	X7S	43	-	82	26723/GFN
<250V	10	17P	67	83	93	26722/GFN
<500V	30	77P	83	-	145	-
<500V	60	97P	121	-	162	-

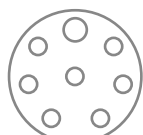

7 pin + earth

voltage	amps	part number	dimensions			saddle clamp*
			D	L	S	
<250V	10	18P	67	83	93	26722/GFN

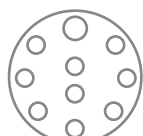

9 pin + earth

voltage	amps	part number	dimensions			saddle clamp*
			D	L	S	
<250V	10	X10P	67	83	93	26722/GFN

Trailing Socket



- IP66 rated
- Brass housing with nickel electroless plating
- Corrosion resistant suitable for harsh environments
- Halogen and Cadmium free
- High shock resistant

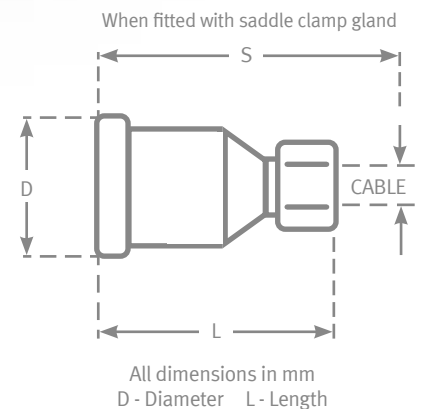

Product Range Overview



2 pin

voltage	amps	part number	dimensions			saddle clamp*
			D	L	S	
<50V	5	X2J	23	45	54	26725/GFN
<250V	10	12J	35	57	69	26724/GFN
<250V	10	12J/ODD	35	57	69	26724/GFN
<250V	15	22J	37	70	82	26723/GFN
<250V	15	22J/ODD	37	70	82	26723/GFN

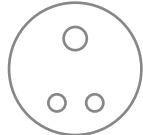

2 pin + earth

voltage	amps	part number	dimensions			saddle clamp*
			D	L	S	
<50V	5	X3J	23	45	54	26725/GFN
<250V	10	13J	35	57	69	26724/GFN
<250V	15	23J	37	70	82	26723/GFN
<250V	30	33J	58	84	98	26722/GFN
<500V	50	43J	55	80	92	26721/GFN
<500V	60	93J	73	-	137	-
<500V	100	53J	86	-	160	-

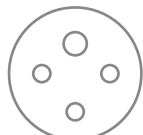

3 pin + earth

voltage	amps	part number	dimensions			saddle clamp*
			D	L	S	
<50V	10	X4J	37	70	82	26725/GFN
<250V	15	64J	46	75	87	26723/GFN
<500V	15	74J	58	84	98	26722/GFN
<500V	60	94J	73	-	137	-
<500V	100	C4J	88	-	215	-

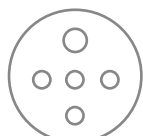

4 pin + earth

voltage	amps	part number	dimensions			saddle clamp*
			D	L	S	
<250V	10	X5J	37	70	82	26723/GFN
<250V	15	65J	46	75	87	26723/GFN
<250V	30	75J	58	88	100	26721/GFN
<500V	50	85J	73	-	145	-
<500V	60	95J	88	-	155	-



5 pin + earth

voltage	amps	part number	dimensions			saddle clamp*
			D	L	S	
<250V	10	X6J	37	70	82	26723/GFN
<500V	30	7J	73	-	145	-

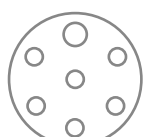

6 pin + earth

voltage	amps	part number	dimensions			saddle clamp
			D	L	S	
<50V	10	X7J	43	80	94	26723/GFN
<250V	10	17J	55	80	92	26722/GFN
<500V	30	77J	73	-	145	-
<500V	60	97J	88	-	155	-

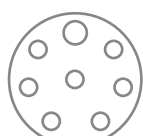

7 pin + earth

voltage	amps	part number	dimensions			saddle clamp*
			D	L	S	
<250V	10	18J	55	80	92	26722/GFN

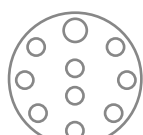

9 pin + earth

voltage	amps	part number	dimensions			saddle clamp*
			D	L	S	
<250V	10	X10J	55	80	92	26722/GFN

Flange Socket 'A' type (3 hole fixing)

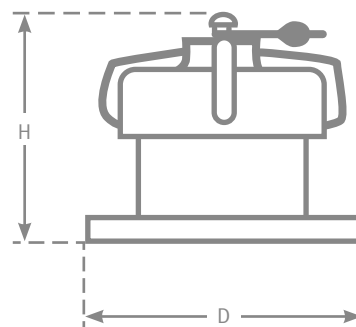

All dimensions in mm
D - Diameter H - Height

- IP66 rated
- Long life sprung contacts
- Operating temperature - 20 to +85°C
- Noryl insulator
- Socket caps manufactured from either Zytel nylon or nylon 66 AF

Product Range Overview

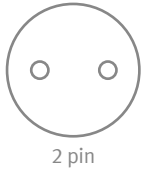

voltage	amps	part number	dimensions		fixing holes			conduit box
			D	H	∅	PCD	No.	
<50V	5	X2A/ODD	38	35	3.2	28.6	3	-
<250V	10	12A	46	38	4.0	36.5	3	1274
<250V	10	12A/ODD	46	38	4.0	36.5	3	1274
<250V	15	22A	57	50	5.2	47.6	3	16302
<250V	15	22A/ODD	57	50	5.2	47.6	3	16302



voltage	amps	part number	dimensions		fixing holes			conduit box
			D	H	∅	PCD	No.	
<50V	5	X3A	38	35	3.2	28.6	3	-
<250V	10	13A	46	38	4.0	36.5	3	1274
<250V	15	23A	57	50	5.2	47.6	3	16302
<250V	30	33A	65	59	5.2	54.0	3	2766
<500V	50	43A	79	70	5.2	66.7	3	1169
<500V	60	93A	96	79	6.6	82.6	3	2333
<500V	100	53A	96	96	6.6	82.6	3	2333

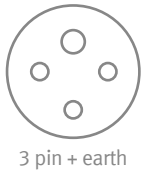

voltage	amps	part number	dimensions		fixing holes			conduit box
			D	H	∅	PCD	No.	
<50V	10	X4A	46	38	4.0	36.5	3	1274
<250V	15	64A	65	54	5.2	53.4	3	2766
<500V	15	74A	65	59	5.2	53.4	3	2766
<500V	60	94A	96	96	6.6	82.6	3	2333
<500V	100	C4A	115	100	7.9	96.8	4	-

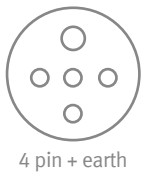

voltage	amps	part number	dimensions		fixing holes			conduit box
			D	H	∅	PCD	No.	
<250V	10	X5A	57	50	5.2	47.6	3	16302
<250V	15	65A	65	54	5.2	54.0	3	2766
<250V	30	75A	78	70	5.2	66.7	3	1169
<500V	50	85A	96	88	6.6	82.6	3	2333
<500V	60	95A	115	83	7.9	96.8	4	-
<500V	250	N55/05	406	350	11.1	177.8	6	-

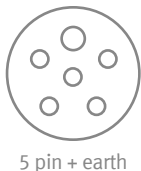

voltage	amps	part number	dimensions		fixing holes			conduit box
			D	H	∅	PCD	No.	
<250V	10	X6A	57	50	5.2	47.6	3	16302
<500V	30	76A	96	88	6.6	82.5	3	2333

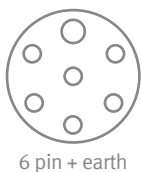

voltage	amps	part number	dimensions		fixing holes			conduit box
			D	H	∅	PCD	No.	
<50V	10	X7A	57	50	5.2	47.6	3	16302
<250V	10	17A	78	57	5.2	66.7	3	1169
<500V	30	77A	96	88	6.6	82.6	3	2333
<500V	60	97A	115	83	7.9	96.8	4	-



voltage	amps	part number	dimensions		fixing holes			conduit box
			D	H	∅	PCD	No.	
<250V	10	18A	78	57	5.2	66.7	3	1169

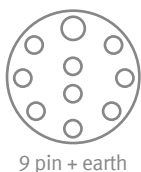

voltage	amps	part number	dimensions		fixing holes			conduit box
			D	H	∅	PCD	No.	
<250V	10	X10A	78	57	5.2	66.7	3	1169

Flange Socket 'B' type (2 hole fixing)



- IP66 rated
- Simple installation, no special tools required
- High dielectric strength
- Excellent insulation properties

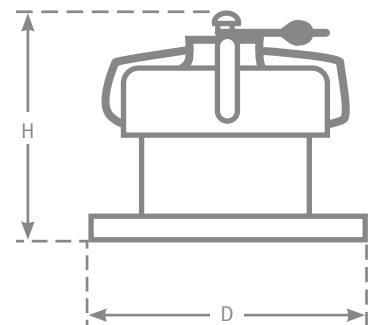

All dimensions in mm
D - Diameter H - Height

Product Range Overview



2 pin

voltage	amps	part number	dimensions		fixing holes		
			D	H	∅	PCD	No.
<50V	5	X2B/ODD	65	35	5.2	50.8	2
<250V	10	12B	65	38	5.2	50.8	2
<250V	10	12B/ODD	65	38	5.2	50.8	2
<250V	15	22B	65	50	5.2	50.8	2
<250V	15	22B/ODD	65	50	5.2	50.8	2

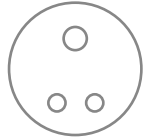

2 pin + earth

voltage	amps	part number	dimensions		fixing holes		
			D	H	∅	PCD	No.
<50V	5	X3B	65	35	5.2	50.8	2
<250V	10	13B	65	38	5.2	50.8	2
<250V	15	23B	65	50	5.2	50.8	2
<250V	30	33B	65	59	5.2	50.8	2

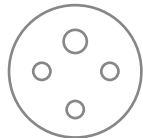

3 pin + earth

voltage	amps	part number	dimensions		fixing holes		
			D	H	∅	PCD	No.
<50V	10	X4B	65	38	5.2	50.8	2
<250V	15	64B	65	54	5.2	50.8	2
<500V	15	74B	65	59	5.2	50.8	2

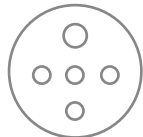

4 pin + earth

voltage	amps	part number	dimensions		fixing holes		
			D	H	∅	PCD	No.
<250V	10	X5B	65	50	5.2	50.8	2
<250V	15	65B	65	54	5.2	50.8	2

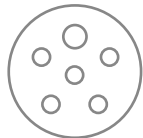

5 pin + earth

voltage	amps	part number	dimensions		fixing holes		
			D	H	∅	PCD	No.
<250V	10	X6B	65	50	5.2	50.8	2

Flange Socket 'B' type is suitable for standard BESA box

Accessories



- IP66 rated
- Noryl insulator
- Good creep resistance
- High dielectric strength
- Halogen and Cadmium free
- Excellent insulation properties
- Saddle clamps manufactured from Zytel nylon resin

Saddle Clamps



Product Range Overview

part number	suits guard plugs & trailing sockets				
26725/GFN	X2	X3	-	-	-
26724/GFN	12	13	X4	-	-
26723/GFN	22	23	64	65	X7
26722/GFN	17	18	33	74	X10
26721/GFN	43	75	-	-	-

Conduit Box

for Type 'A' flange only

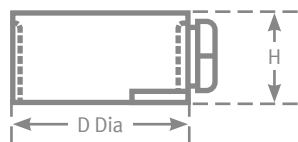
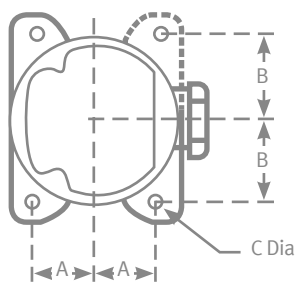

Product Range Overview

part number	dimensions		fixing holes			
	D	H	Ø	A	B	No.
1274	45	30	5.5	17.5	24.0	2
16302	58	30	5.5	20.0	23.5	2
2766	65	36	6.5	22.0	34.5	2
1169	81	40	8.0	36.0	36.0	2
2333	96	59	9.5	38.0	44.5	4

D - Diameter H - Height Fixing holes;
Ø (Diameter), A and B centres from centre

All dimensions in mm

Connector Adaptor



Product Range Overview

part number	sockets to convert	adaptor
29618	13S or 13J	M16
34857	23S or 23J	M20
34857	65S or 65J	M20
34857	23S/FR	M20

The adaptor converts the socket thread to a standard M16 or M20 so that it can be screwed into standard metric fittings.

Appliance Inlet



- IP66 rated
- High shock resistant
- Excellent insulation properties
- Good creep resistance

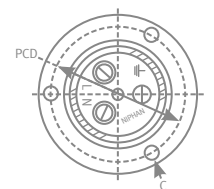
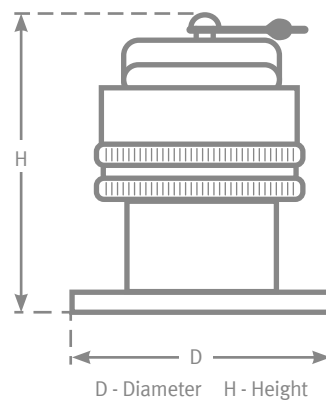

C - Diameter
PCD - Pitch Centre Diameter

All dimensions in mm

Product Range Overview

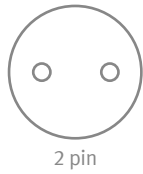

voltage	amps	part number	dimensions		fixing holes			conduit box
			D	H	∅	PCD	No.	
<50V	5	X2Q/OOD	38	43	3.2	28.6	3	-
<250V	10	12R	46	51	3.0	36.5	3	1274
<250V	10	12R/ODD	46	51	3.0	36.5	3	1274
<250V	15	22R	57	70	3.0	47.6	3	16302
<250V	15	22R/ODD	57	70	3.0	47.6	3	16302



voltage	amps	part number	dimensions		fixing holes			conduit box
			D	H	∅	PCD	No.	
<50V	5	X3R	38	43	3.2	28.6	3	-
<250V	10	13R	46	51	4.0	36.5	3	1274
<250V	15	23R	57	70	5.2	47.6	3	16302
<250V	30	33R	65	76	5.2	54.0	3	2766
<500V	50	43R	78	80	5.2	66.7	3	1169
<500V	60	93R	96	90	6.6	82.6	3	2333
<500V	100	53R	96	100	6.6	82.6	3	2333



voltage	amps	part number	dimensions		fixing holes			conduit box
			D	H	∅	PCD	No.	
<50V	10	X4R	46	51	4.0	36.5	3	1274
<250V	15	64R	65	76	5.2	54.0	3	2766
<500V	15	74R	65	76	5.2	54.0	3	2766
<500V	60	94R	96	90	6.6	82.6	3	2333
<500V	100	C4R	115	132	7.9	96.8	4	-

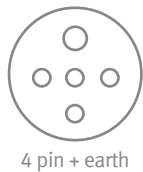

voltage	amps	part number	dimensions		fixing holes			conduit box
			D	H	∅	PCD	No.	
<250V	10	X5R	57	70	5.2	47.6	3	16302
<250V	15	65R	65	76	5.2	54.0	3	2766
<250V	30	75R	78	80	5.2	66.7	3	1169
<500V	50	85Q	96	90	6.6	82.6	3	2333
<500V	60	95Q	115	95	7.9	96.8	4	-

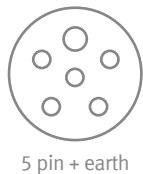

voltage	amps	part number	dimensions		fixing holes			conduit box
			D	H	∅	PCD	No.	
<250V	10	X6R	57	70	5.2	47.6	3	16302
<500V	30	76Q	96	92	6.7	82.6	3	2333

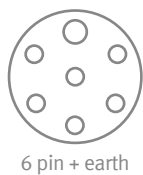

voltage	amps	part number	dimensions		fixing holes			conduit box
			D	H	∅	PCD	No.	
<50V	10	X7R	57	43	5.2	47.6	3	16302
<250V	10	17Q	78	53	5.2	66.7	3	1169
<500V	30	77Q	96	92	6.6	82.6	4	2333
<500V	60	97Q	115	95	7.9	96.8	-	-

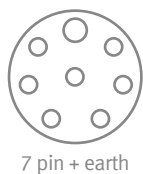

voltage	amps	part number	dimensions		fixing holes			conduit box
			D	H	∅	PCD	No.	
<250V	10	18Q	78	53	5.2	66.7	3	1169

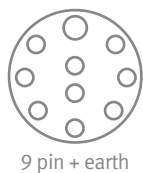

voltage	amps	part number	dimensions		fixing holes			conduit box
			D	H	∅	PCD	No.	
<250V	10	X10Q	78	53	5.2	66.7	3	1169

Panel Mount



- M20 bulkhead thread
- Bulkhead nut not included
- Noryl insert
- Maximum conductor size 1.5mm²
- Screw terminal connection
- IP66 rated



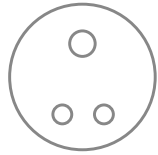

2 pin + earth

voltage	amps	part number	description
250V	10	13S/Y	Panel mount plug with cap
250V	10	13Y	Panel mount socket with cap

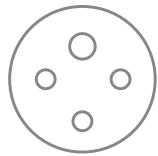

3 pin + earth

voltage	amps	part number	description
<250V	15	64S/Y	square ended plug

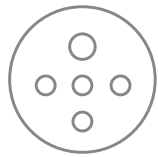

4 pin + earth

voltage	amps	part number	description
<250V	15	65S/Y	square ended plug

Bespoke Assemblies & Cable Harnesses





LPA offer bespoke assemblies and cable harnesses to meet customer requirements.

- Customer specified cable lengths
- Various cable types available
- Choice of connector including third party
- HV, LV, comms, data and ethernet circuitry options
- Various conduit solutions
- Inclusion of junction box if required
- In house testing and repair service
- Design assistance available
- Compliant with customer required standards
- LSZH options
- EN45545 compliance where applicable
- Type testing available

Nato (NSN) Cross Reference

LPA reference	NSN reference	description
11A	5935-99-203-9683	Socket, electrical
12A	5935-99-427-7336	Connector, fixed, electrical
12A	5935-99-433-3925	Connector, fixed, electrical
12A/ODD	5935-99-434-5345	Connector, receptacle, electrical
12A/SL	5935-99-759-1505	Connector, fixed, electrical
12B	5935-99-803-1814	Socket, electrical
12S	5935-99-202-2483	Connector, plug, electrical
12S	5935-99-299-8970	Connector, free, electrical
12S/ODD	5935-99-798-6360	Connector, plug, electrical
12SAD	5935-99-427-7280	Connector, free, electrical
13A	5935-99-427-7290	Connector, fixed, electrical
13A16675	5935-99-621-9451	Connector, receptacle, electrical
13A1NS	5935-99-519-6844	Connector, receptacle, electrical
13B	5935-99-427-7339	Connector, receptacle, electrical
13B	5935-99-950-8104	Connector, receptacle, electrical
13C	5935-99-944-2719	Socket, electrical
13D	5935-99-944-2720	Socket, electrical
13J	5935-99-943-9274	Connector, plug, electrical
13J1NS	5935-99-527-8205	Socket, electrical
13J1NS	5935-99-955-2744	Connector, free, electrical
13J443	5935-99-193-6684	Socket, electrical
13JA36	5935-99-427-7284	Connector, free, electrical
13JR	5935-99-622-9222	Socket, electrical
13R/INS	5935-99-100-3916	Connector, fixed, electrical
13S	5935-99-195-3236	Connector, free, electrical
13Y	5935-99-748-5693	Connector, fixed, electrical
14A	5935-99-434-5340	Connector, fixed, electrical
15A	5935-99-530-3413	Connector, fixed, electrical
15J	5935-99-716-6015	Socket, electrical
15P	5935-99-535-0536	Connector, free, electrical
17A	5935-99-427-7366	Connector, receptacle, electrical
22A	5935-99-620-0476	Connector, receptacle, electrical
22AODD	5935-99-434-5346	Connector, receptacle, electrical
22SODD	5935-99-434-5471	Connector, plug, electrical
23A	5935-99-199-3536	Connector, fixed, electrical
23A1NS	5935-99-117-9914	Connector, receptacle, electrical
23A1NS	5935-99-427-7358	Connector, fixed, electrical
23B	5935-99-427-7313	Connector, receptacle, electrical
23J	5935-99-110-2228	Connector, plug, electrical
23J	5935-99-110-5057	Socket, electrical
23JR	5935-99-222-6104	Socket, electrical
23S	5935-99-434-5554	Connector, plug, electrical
23S	5935-99-948-2278	Connector, free, electrical
32J	5935-99-450-2965	Connector, free, electrical
32J/A36	5935-99-759-7690	Connector, plug, electrical
32JODD	5935-99-805-3629	Connector, free, electrical
32R	5935-99-845-9533	Connector, fixed, electrical
32RODD	5935-99-434-5343	Connector, receptacle, electrical
33A	5935-99-427-7348	Connector, receptacle, electrical
33J/A36	5935-99-759-7691	Connector, plug, electrical
33R	5935-99-434-5328	Connector, receptacle, electrical
33R	5935-99-434-5328	Connector, receptacle, electrical
42JODD	5935-99-104-3147	Connector, plug, electrical

LPA reference	NSN reference	description
43A	5935-99-427-7278	Connector, fixed, electrical
43R	5935-99-434-5337	Connector, receptacle, electrical
43S	5935-99-195-4988	Plug, electrical
53A	5935-99-427-7276	Connector, receptacle, electrical
53R	5935-99-434-5318	Connector, receptacle, electrical
53SAD	5935-99-427-7275	Connector, plug, electrical
63SAD	5935-99-193-6633	Plug, electrical
64A	5935-99-775-9262	Connector, fixed, electrical
64R	5935-99-900-4922	Plug, electrical
64S	5935-99-001-5433	Connector, free, electrical
65A	5935-99-427-7438	Connector, receptacle, electrical
65S	5935-99-743-1728	Connector, free, electrical
65SAD	5935-99-427-7437	Connector, plug, electrical
73J	5935-99-972-7967	Connector, plug, electrical
73S	5935-99-131-0781	Connector, plug, electrical
74A	5935-99-117-6655	Socket, electrical
74C	5935-99-944-2718	Socket, electrical
74R	5935-99-434-5326	Connector, receptacle, electrical
74SS	5935-99-951-6390	Plug, electrical
74Y	5935-99-944-2721	Socket, electrical
84S	5935-99-434-5522	Connector, plug, electrical
85J	5935-99-739-2065	Connector, free, electrical
85P	5935-99-745-0673	Connector, plug, electrical
93A	5935-99-193-6680	Connector, fixed, electrical
93J	5935-99-434-5774	Connector, plug, electrical
93R	5935-99-434-5773	Connector, receptacle, electrical
93SAD	5935-99-427-7274	Connector, plug, electrical
94A	5935-99-198-7210	Connector, fixed, electrical
94J	5935-99-797-2472	Connector, free, electrical
94J/INS	5935-99-253-9888	Connector, free, electrical
94R	5935-99-797-2471	Connector, fixed, electrical
C4J	5935-99-593-2130	Connector, plug, electrical
C4J/A36	5935-99-764-4885	Connector, free, electrical
C4R	5935-99-434-9658	Connector, receptacle, electrical
C5S	5935-99-930-8128	Connector, plug, electrical
C94A	5935-99-434-5560	Connector, receptacle, electrical
C94J	5935-99-434-5559	Connector, plug, electrical
C94S	5935-99-434-5561	Connector, plug, electrical
X2AODD	5935-99-104-7596	Connector, fixed, electrical
X2JODD	5935-99-532-8662	Connector, plug, electrical
X2P/ODD	5935-99-004-1028	Connector, plug, electrical
X2QODD	5935-99-650-7610	Connector, receptacle, electrical
X3A	5935-99-105-6382	Connector, fixed, electrical
X3J	5935-99-647-5385	Socket, electrical
X3P	5935-99-534-7104	Connector, free, electrical
X4A	5935-99-427-7286	Connector, fixed, electrical
X4A1NS	5935-99-203-9682	Socket, electrical
X4B	5935-99-838-6324	Connector, receptacle, electrical
X4C	5935-99-944-2722	Socket, electrical
X4JA36	5935-99-427-7288	Connector, free, electrical
X4RAD	5935-99-427-7285	Connector, fixed, electrical
X5A	5935-99-661-3291	Connector, receptacle, electrical
X5B	5935-99-193-6662	Socket, electrical
X5SAD	5935-99-427-7338	Connector, plug, electrical

Technical Information

Environmental protection:

The LPA Niphan range of weatherproof connectors offer protection against the ingress of dust and liquids provided all fixing and earthing screws are correctly located and tightened.

The Niphan connectors have been tested to IP66 in accordance with EN 60529.

Quality Assurance:

The LPA Niphan range of electrical couplings are manufactured and comply with the highest industrial standards. They undergo rigorous testing and inspection during manufacture. All units are subjected to a high voltage flash test, at twice

the rated voltage (+1000V) between all poles and earth.

Quality Logo:

LPA Connection Systems is a BS EN IS) 9001:2015 approved company.

Product compliance:

LPA's Niphan connectors complies with the following standards and directives:

- BS EN 6194B:2009 Connectors safety requirements and tests
- BS EN 60309-1:1999 + A2:2012
- Low Voltage Directive (LVD2014/35/EU)
- RoHS Directive (2011/66/EU)

Sealing covers:

All flange mounted sockets with suffix A and B, and flange mounted plugs with suffix Q and R come supplied with protective covers to ensure their IP rating is maintained when unmated.

Polarity:

2 pole connectors have contacts of equal diameter and are equi-spaced. If no-reversal characteristics are required, add /ODD to the part number 9e.g. 125 = 125/ODD).

Alternative products:

When saddle clamps are required to replace cable gripping nuts, add suffix /A36 e.g. 12S/A36. For all Poles insulated, add suffix /INS e.g. 1 3S/INS.

lpa connection systems

Light & Power House,
Shire Hill, Saffron Walden,
CB11 3AQ, UK
+44 (0)1799 512800
enquiries@lpa-connect.com

LPA Group Plc

Light & Power House,
Shire Hill, Saffron Walden,
CB11 3AQ, UK
+44 (0)1799 512800
enquiries@lpa-group.com

LPA Channel Electric

Bath Road,
Thatcham, Berkshire,
RG18 3ST. UK
+44 (0)1635 864866
enquiries@lpa-channel.com

LPA Lighting Systems

LPA House, Ripley Drive,
Normanton, West Yorkshire,
WF6 1QT. UK
+44 (0)1924 224100
enquiries@lpa-light.com

LPA Transport +®

Light & Power House,
Shire Hill, Saffron Walden,
CB11 3AQ, UK
+44 (0)1799 512800
enquiries@lpa-connect.com

www.lpa-group.com



FM 01660

LPAPub.No.091/0720/150